

UPJ-1XP Compact VariO™ Loudspeaker

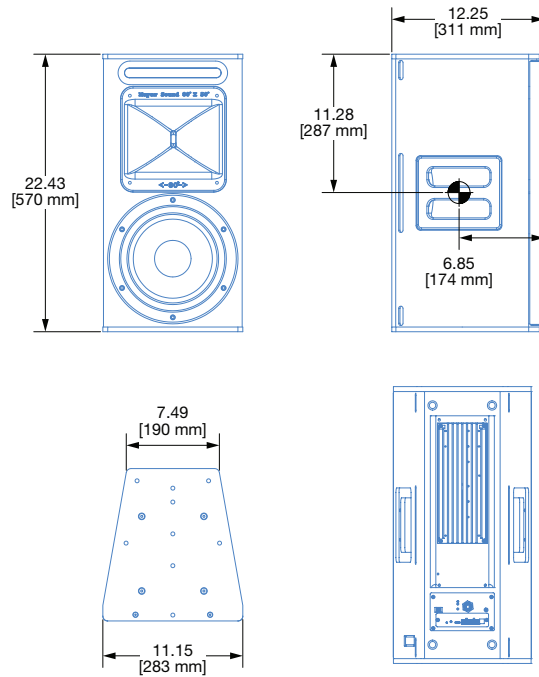

Meyer Sound designed the UPJ-1XP for flexibility. The UPJ-1XP (with IntelligentDC technology) offers the same sonic signature, robust peak power output, and rotatable VariO horn as the UPJ-1P but with external DC power and support for lengthy cable runs without AC conduits. Its extraordinary size-to-power ratio and generous rigging options make the compact UPJ-1XP well suited for use as a single, primary loudspeaker or as part of multi-cabinet horizontal or vertical clusters.

Applications include AV presentations, small- to medium-sized sound reinforcement systems, fill, delay, effects, and distributed systems. With its ability to rotate, the loudspeaker's 80° by 50° VariO horn facilitates optimum horizontal or vertical coverage for any installation.

Designed and manufactured at Meyer Sound's factory in Berkeley, California, the UPJ-1XP's transducers include one 10-inch cone driver and one 3-inch diaphragm compression driver. An onboard two-channel, class D amplifier delivers 550 W peak power to the proprietary drivers.

With IntelligentDC technology, the UPJ-1XP receives DC power and balanced audio from a single loudspeaker connector, available as Phoenix™ 5-pin male, sealed SwitchCraft® EN3™ 5-pin male, or sealed ECO-M 7-pin male. Powering the unit from an external source eliminates the need for wiring conduits while still preserving the advantages of self-powered systems. The UPJ-1XP's amplifier and signal-processing circuits store DC power and tolerate voltage drops, thereby accommodating light-gauge cables and lengthy cable runs.

The UPJ-1XP requires an external Meyer Sound IntelligentDC power supply. The MPS-488HP single-space rack unit distributes DC power and balanced audio to up to eight UPJ-1XP loudspeakers, or other Meyer Sound IntelligentDC loudspeakers. For systems requiring fewer speakers, the two channel MPS-482HP is also available.

Composite multiconductor cables, such as Belden® 1502 or equivalent, can deliver both DC power and balanced audio to loudspeakers at cable lengths up to 150 feet with just 1 dB of loss in peak SPL using 18 AWG wire. Longer cable runs are possible with heavier gauge wires.

Meyer Sound's RMS™ remote monitoring system, which offers comprehensive monitoring of loudspeaker parameters from a Mac® or Windows®-based computer running Compass® control software, is optionally available for the MPS-488HP.

Meyer Sound coats the UPJ-1XP cabinet with a slightly textured black finish and includes heavy-duty, corrosion-resistant 6061-T6 aluminum end plates with threaded M8 attachment points for basic eyebolt rigging and third-party pole assemblies. QuickFly® rigging options include the MAAM-UPJ array adapter (also made from 6061-T6 aluminum), MUB-UPJ U-bracket, and MYA-UPJ mounting yoke assembly. Cabinets without handles are also available from the factory. Other options include weather protection and custom colors for fixed installations and installations with specific cosmetic requirements.

## FEATURES AND BENEFITS

---

- IntelligentDC technology affords the flexibility of lengthy cable runs without AC conduits
- Exceptional fidelity and extended high-frequency enhance performance
- Extraordinarily flat amplitude and phase response provide tonal accuracy and precise imaging
- Constant-Q horn affords uniform response throughout the coverage area
- VariO horn enables versatile coverage options, whether orienting loudspeakers horizontally or vertically
- QuickFly rigging enables single cabinet mounting or flown, multi-cabinet horizontal and vertical arrays

## APPLICATIONS

---

- Portable and installed audio-visual systems
- Theatrical sound reinforcement
- Compact voice reinforcement systems
- Conference centers, presentations, ballrooms, and houses of worship

## ACCESSORIES AND ASSOCIATED PRODUCTS

---

**MAAM-UPJ Array Adapter:** Facilitates installation of multiple UPJ-1XPs in both horizontal and vertical arrays.

**MYA-UPJ Mounting Yoke Assembly:** Cradle-style mounting yoke that suspends a single UPJ-1XP loudspeaker and supports a wide range of horizontal and vertical adjustments.

**MUB-UPJ U-Bracket:** Allows the UPJ-1XP to be mounted on any flat surface at adjustable angles.

**35MM Pole Stand Adapter:** This large base stand adapter mounts the loudspeaker on a 35 mm pole. In addition, this adapter can be used to mount the MYA-UPJ yoke on a pole to allow easy panning and tilting.

**MSA-STAND Adapter Cup 35MM:** This compact cup-type adapter mounts the UPJ-1XP loudspeaker on a 35 mm pole. In addition, this adapter can be used to mount the MYA-UPJ yoke on a pole to allow easy panning and tilting of the UPJ-1XP.

**Galileo GALAXY Network Platform:** The Galileo GALAXY Network Platform provides state-of-the-art audio control technology for loudspeaker systems with multiple zones. With immaculate sonic performance, it provides a powerful tool set for corrective room equalization and creative fine-tuning for a full range of applications.

**MPS-488HP External Power Supply:** Rack-mount unit that delivers balanced audio and high-current DC power to up to eight loudspeakers; versions available with either Phoenix or EN3 channel output connectors.

**MPS-482HP External Power Supply:** 1RU 1/2 width rack unit that delivers balanced audio and high-current DC power to up to two audio channels; rack mount or use available options to mount on ceiling, wall, pole or truss configurations.

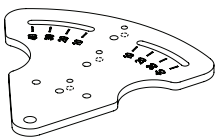

MAAM-UPJ Array Adapter

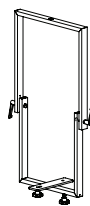

MYA-UPJ Mounting Yoke Assembly

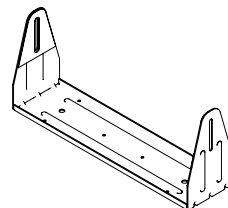

MUB-UPJ U-Bracket

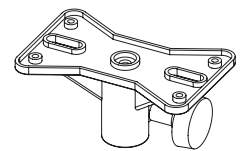

35MM Pole Stand Adapter

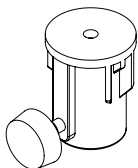

MSA-STAND Adapter Cup 35MM



Galileo GALAXY Network Platform

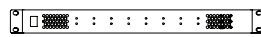

MPS-488HP External Power Supply

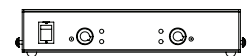

MPS-482HP External Power Supply

## SPECIFICATIONS

ACOUSTICAL <sup>1</sup>			
Operating Frequency Range <sup>2</sup>	55 Hz – 20 kHz		
Frequency Response <sup>3</sup>	66 Hz – 18 kHz ±4 dB		
Phase Response	750 Hz – 18 kHz ±45 degrees		
Linear Peak SPL <sup>4</sup>	<b>125 dB with 18 dB crest factor (M-noise)</b> , 122.5 dB (Pink noise), 125 dB (B-noise)		
COVERAGE <sup>5</sup>			
	50° x 80° or 80° x 50° (rotatable horn)		
TRANSDUCERS			
Low Frequency	One 10-inch cone driver; 4 Ω nominal impedance		
High Frequency	One 3-inch diaphragm compression driver; 16 Ω nominal impedance		
AUDIO INPUT			
Type	Differential, electronically balanced		
Maximum Common Mode Range	±15 V DC, clamped to earth for voltage transient protection		
Connectors	Phoenix 5-pin Male; SwitchCraft 5-pin Male; ECO-M 7-pin Male (two pins for 48 V DC power, three pins for balanced audio)		
Input Impedance	10 kΩ differential between positive (+) and negative (-) audio pins		
Wiring <sup>6</sup>	Phoenix 5-pin Male Pin 1: DC Power (-) Pin 2: DC Power (+) Pin 3: Chassis/earth through 1 kΩ, 1000 pF, 15 V clamp network to provide virtual ground lift at audio frequencies Pin 4: Audio (-) Pin 5: Audio (+)	SwitchCraft EN3 5-pin Male Pin 1: DC Power (-) Pin 2: DC Power (+) Pin 3: Chassis/earth through 1 kΩ, 1000 pF, 15 V clamp network to provide virtual ground lift at audio frequencies Pin 4: Audio (-) Pin 5: Audio (+)	ECO-M 7-pin Male <sup>5</sup> Pin 1: DC Power (-) Pin 2: DC Power (+) Pin S: Chassis/earth through 1 kΩ, 1000 pF, 15 V clamp network to provide virtual ground lift at audio frequencies Pin 5: Audio (-) Pin 6: Audio (+)
Nominal Input Sensitivity	0 dBV (1.0 V rms) continuous is typically the onset of limiting for noise and music		
Input Level	Audio source must be capable of producing of +20 dBV (10 V rms) into 600 Ω to produce the maximum peak SPL over the operating bandwidth of the loudspeaker.		
AMPLIFIER			
Type	2-channel, Class-D		
Total Output Power <sup>7</sup>	550 W peak		
THD, IM, TIM	< 0.02%		
Cooling	Convection		
DC POWER			
Connector	Phoenix 5-pin Male; SwitchCraft 5-pin Male; ECO-M 7-pin Male (two pins for 48 V DC power, three pins for balanced audio)		
Safety Rated Voltage Range	48 V DC		
RMS NETWORK (OPTIONAL ON REQUIRED MPS-488HP POWER SUPPLY)			
	Equipped with two-conductor twisted-pair network, reporting all operating parameters of amplifiers to system operator's host computer.		

## SPECIFICATIONS, CONT'D.

PHYSICAL	
Dimensions	W: 11.15 in (283 mm) x H: 22.43 in (570 mm) x D: 12.25 in (311 mm)
Weight	43 lb (19.5 kg)
Enclosure	Premium multi-ply birch with slightly textured black finish
Protective Grille	Powder-coated, hex-stamped steel with black mesh
Rigging	Aluminum end plates with M8 threaded attachment points for mounting and flying with QuickFly and standard rigging options

## NOTES

- Loudspeaker system predictions for coverage and SPL are available in Meyer Sound's MAPP System Design Tool.
- Recommended maximum operating frequency range. Response depends on loading conditions and room acoustics.
- Free-field, measured with 1/3-octave frequency resolution at 4 m.
- Linear Peak SPL** is measured in free-field at 4 m referred to 1 m. Loudspeaker SPL compression measured with M-noise at the onset of limiting, 2-hour duration, and 50-degree C ambient temperature is <2 dB.  
**M-noise** is a full bandwidth (10 Hz–22.5 kHz) test signal developed by Meyer Sound to better measure the loudspeaker's music performance. It has a constant instantaneous peak level in octave bands, a crest factor that increases with frequency, and a full bandwidth Peak to RMS ratio of 18 dB.  
**Pinknoise** is a full bandwidth test signal with Peak to RMS ratio of 12.5 dB.  
**B-noise** is a Meyer Sound test signal used to ensure measurements reflect system behavior when reproducing the most common input spectrum, and to verify there is still headroom over pink noise.
- The UPJ horn can be rotated to provide an 80° x 50° coverage pattern in either the horizontal or vertical plane.
- Pins 3 and 4 not used in ECO-M connector.
- Amplifier wattage rating based on the maximum unclipped burst sine wave rms voltage the amplifier will produce for at least 0.5 seconds into the nominal load impedance: low and high channels, 30 V rms.

## ARCHITECTURAL SPECIFICATIONS

The loudspeaker shall be a self-powered, full-range system. Its transducers shall include one 10-inch cone driver and one 3-inch diaphragm compression driver.

The loudspeaker system shall incorporate internal processing and a two-channel amplifier, one channel for each driver. Processing functions shall include equalization, phase correction, signal division, and driver protection. Amplifier burst output power shall be 550 W total. Distortion (THD, IM, TIM) shall not exceed 0.02%.

Performance specifications for a typical production unit shall be as follows: operating frequency range shall be 55 Hz – 20 kHz; phase response shall be 750 Hz – 18 kHz ±45°; linear Peak SPL shall be 125 dB with 18 dB crest factor, measured with M-noise, free-field at 4 m referred to 1 m; coverage (-6 dB points) shall be 80° x 50°, horizontal or vertical dependent on horn orientation.

The loudspeaker shall receive DC power and balanced audio from a single input connector, available as Phoenix 5-pin male, sealed EN3 5-pin

male, or sealed ECO-M 7-pin male (two pins for DC power, three pins for balanced audio). The audio input shall be electronically balanced with a 10 kΩ impedance and accept a nominal 0.0 dBV (1.0 V rms) input signal.

Power requirements for the loudspeaker shall be a Meyer Sound Intelligent DC power supply capable of delivering 48 V DC.

All components shall be mounted in an acoustically vented trapezoidal enclosure constructed of premium multi-ply birch with a slightly textured black finish. The protective grille shall be powder-coated, hex-stamped steel with black mesh. Integral high-strength, 6061-T6 aluminum end plates with threaded M8 metric holes shall accommodate Meyer Sound proprietary rigging hardware and third-party accessories. Dimensions shall be W: 11.15 in (283 mm) x H: 22.43 in (570 mm) x D: 12.25 in (311 mm). Weight shall be 43 lb (19.5 kg).

The loudspeaker shall be the Meyer Sound UPJ-1XP.